

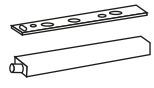

8



2



1



12



12



14



4



1



Diversa Sp. z o. o.
u. Krasnowolska 50, 02-849 Warszawa
Zakład w Prudniku:
ul. Prężyńska 23, 48-200 Prudnik
tel. (+48) 77 436 41 11
e-mail: biuro@diversa.com.pl
www.diversa.info.pl

Instrukcja montażu — Bauanleitung — Assembly instrucion — Instrukce — Instruction de montage — Istruzione di montaggio — Instruccio de montaje

AQUATIC

60x30x90

60x40x90

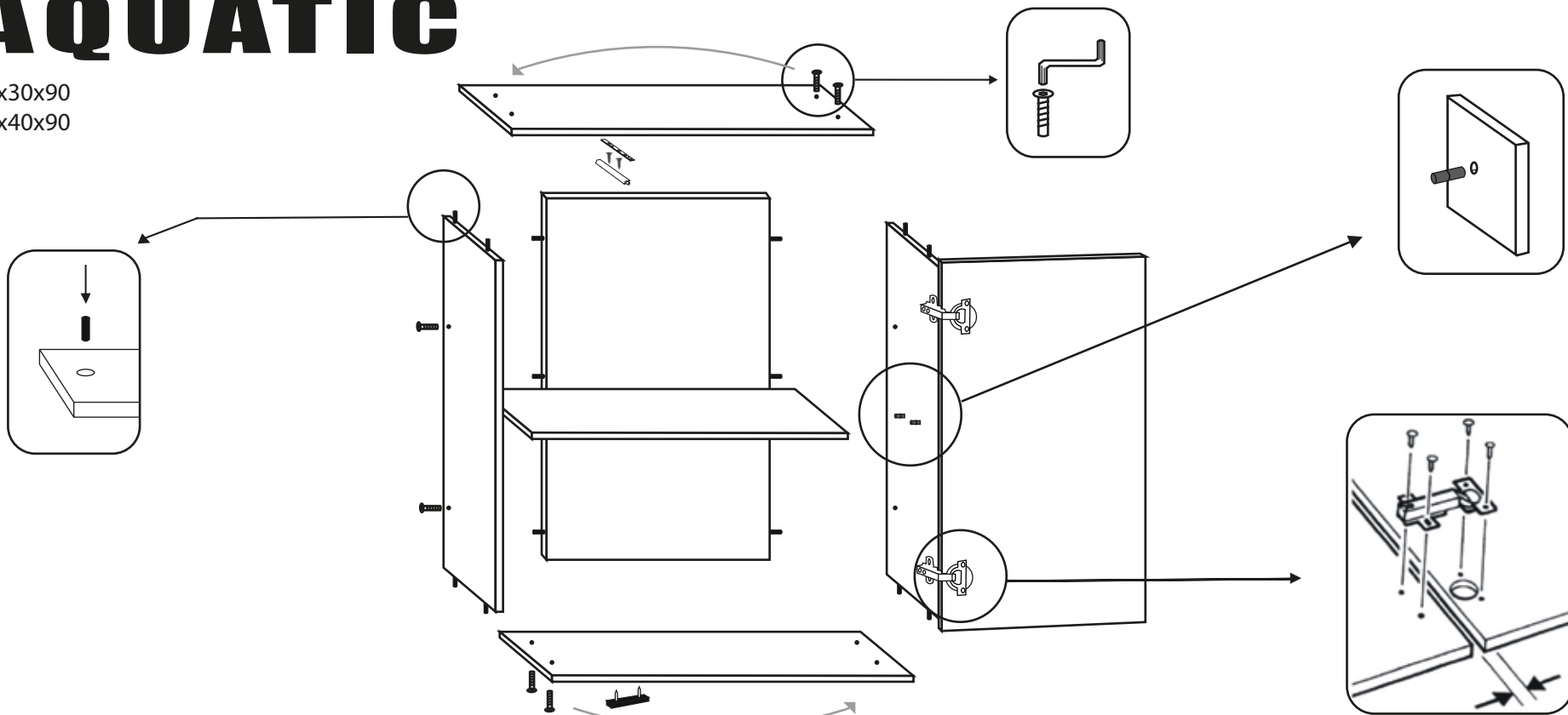

1



2

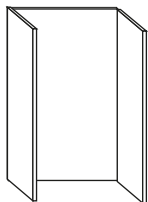

3

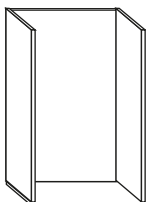

4

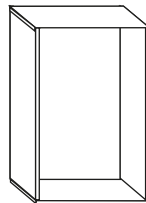

5

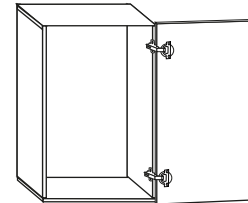

6

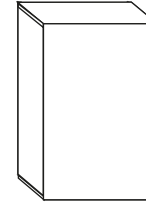



10

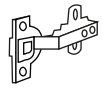

4

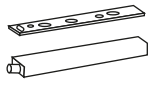

2



24



20



31



4

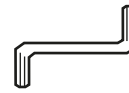

1



Diversa Sp. z o. o.
 u. Krasnowolska 50, 02-849 Warszawa
 Zakład w Prudniku:
 ul. Prężyńska 23, 48-200 Prudnik
 tel. (+48) 77 436 41 11
 e-mail: biuro@diversa.com.pl
 www.diversa.info.pl

Instrukcja montażu – Bauanleitung – Assembly instruction – Instrukce – Instruction de montage – Istruzione di montaggio – Instruccio de montaje

AQUATIC

90x60x90
 100x60x90

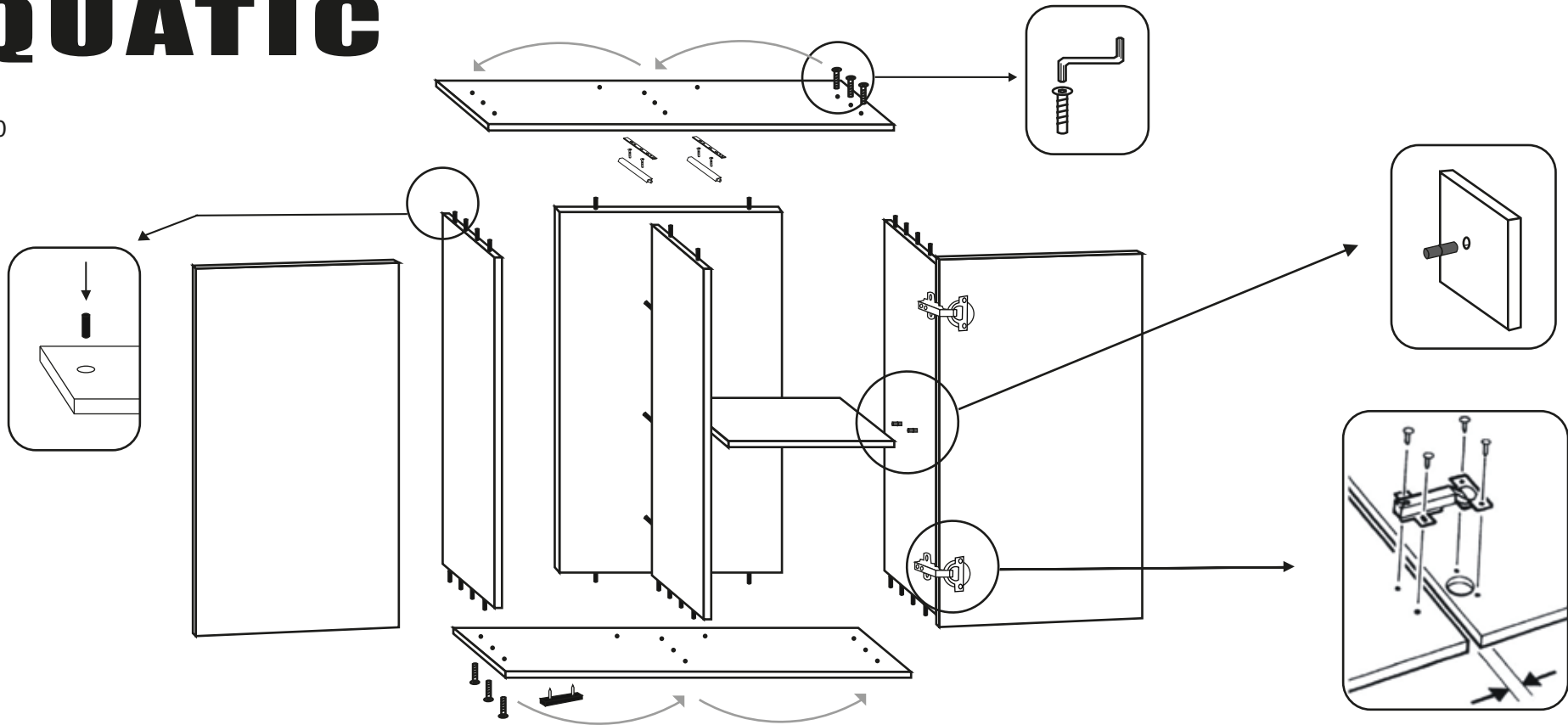

1

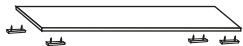

2

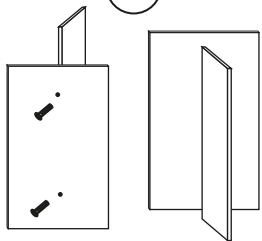

3

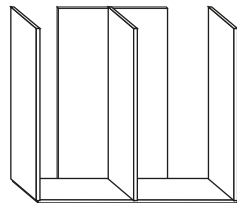

4

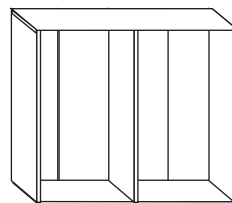

5

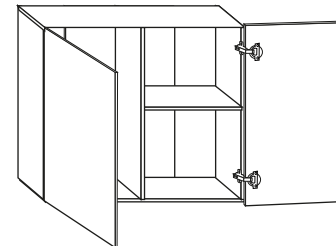

6

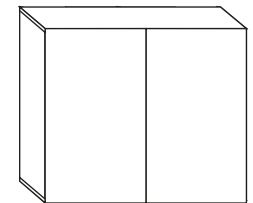



10

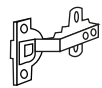

4

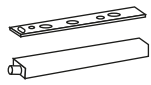

2



18



20



19



4



1



Diversa Sp. z o.o.
u. Krasnowolska 50, 02-849 Warszawa
Zakład w Prudniku:
ul. Prężyńska 23, 48-200 Prudnik
tel. (+48) 77 436 41 11
e-mail: biuro@diversa.com.pl
www.diversa.info.pl

Instrukcja montażu — Bauanleitung — Assembly instrucion — Instrukce — Instruction de montage — Istruzione di montaggio — Instruccio de montaje

AQUATIC

80x35x90
90x45x90
100x40x90
100x50x90

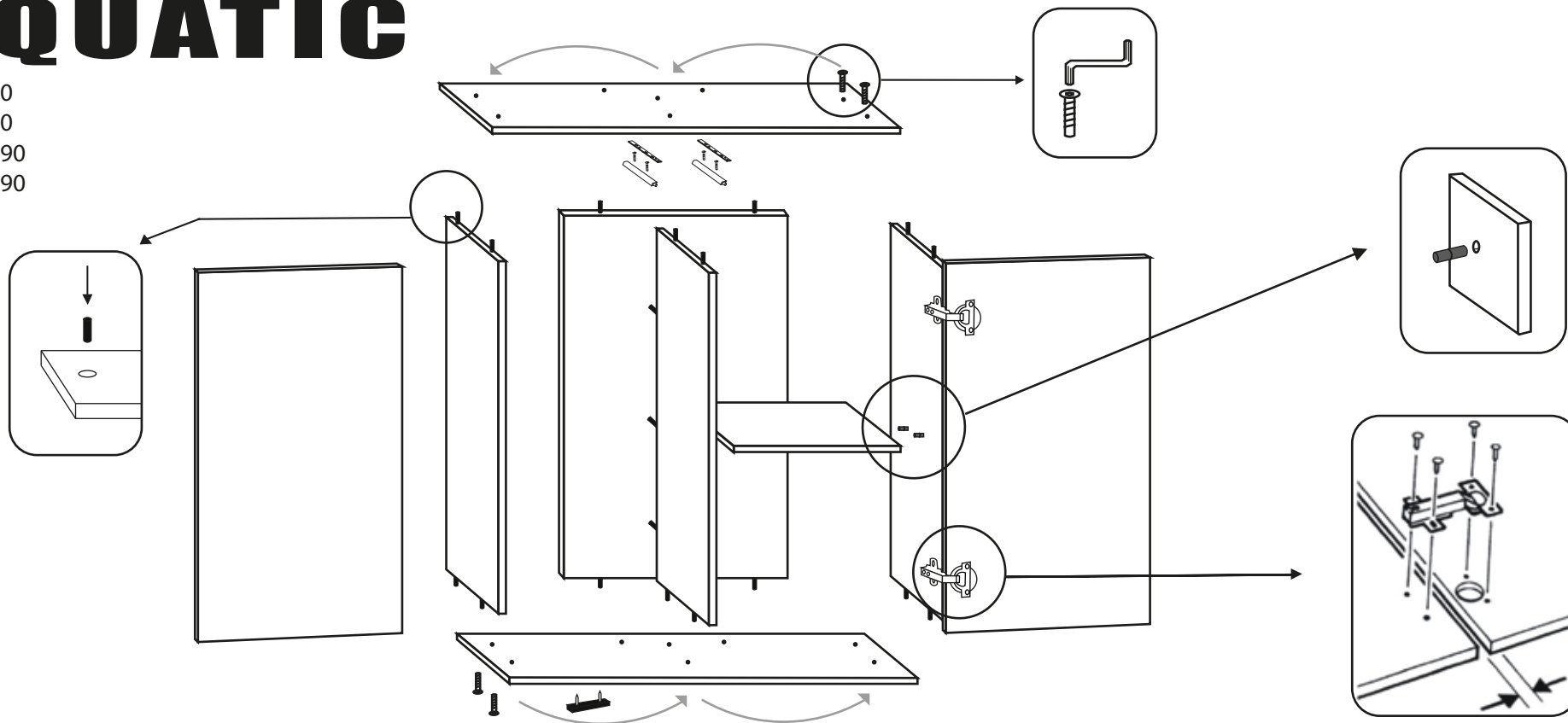

1



2

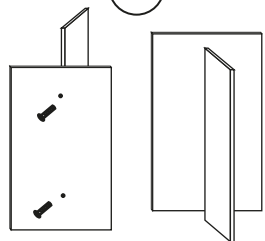

3

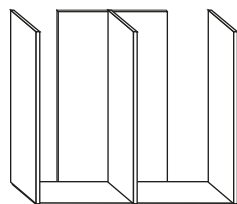

4

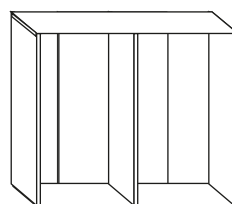

5

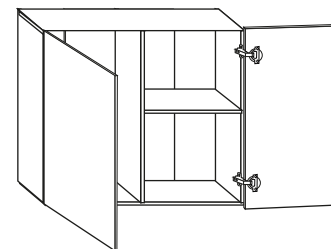

6

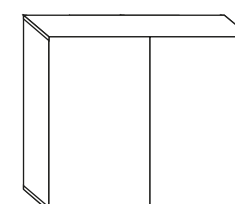

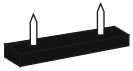

12



6

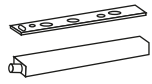

3



36



30



46



8

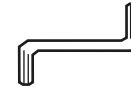

1



Diversa Sp. z o. o.
 u. Krasnowolska 50, 02-849 Warszawa
 Zakład w Prudniku:
 ul. Prężyńska 23, 48-200 Prudnik
 tel. (+48) 77 436 41 11
 e-mail: biuro@diversa.com.pl
 www.diversa.info.pl

Instrukcja montażu — Bauanleitung — Assembly instrucion — Instrukce — Instruction de montage — Istruzione di montaggio — Instruccio de montaje

AQUATIC

120x60x90
 150x60x90
 160x60x90

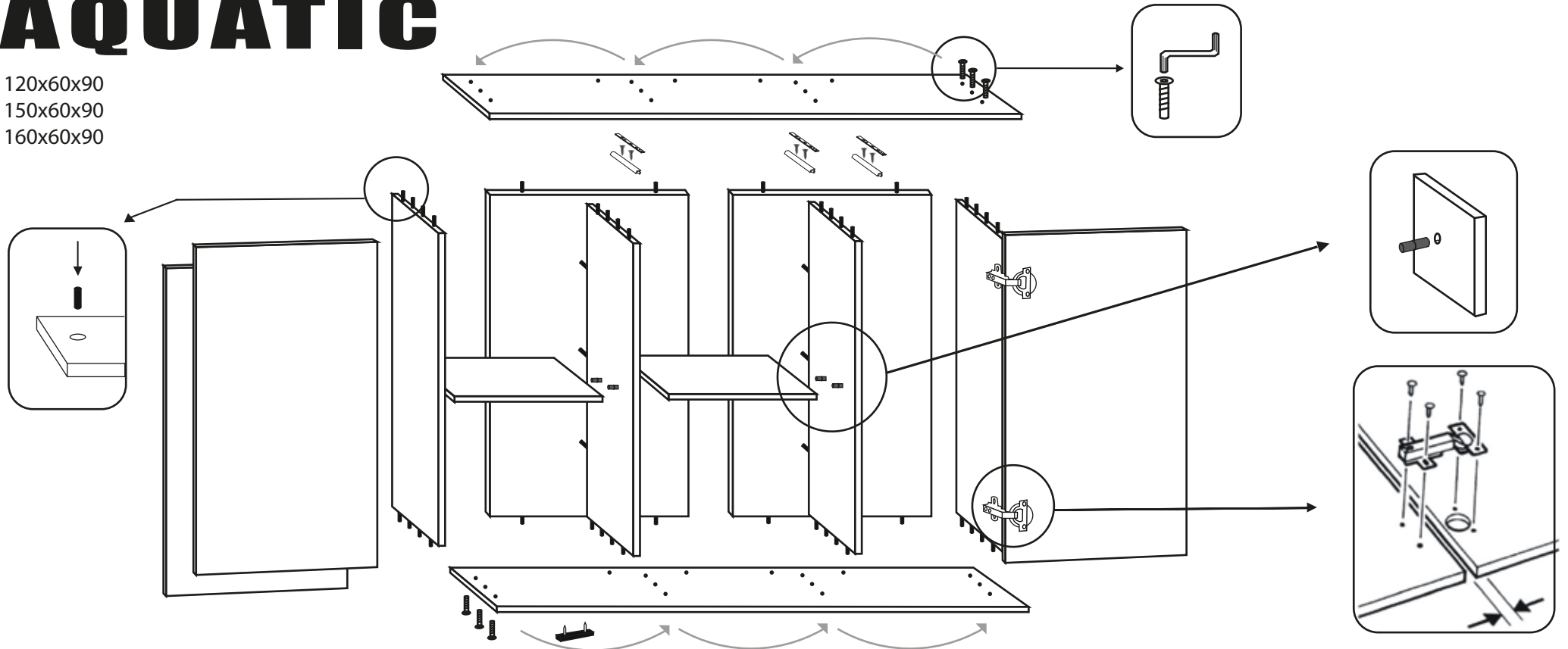

1



2

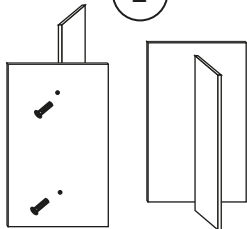

3

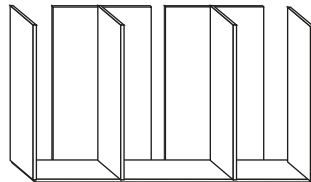

4

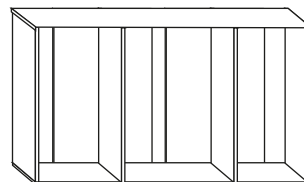

5

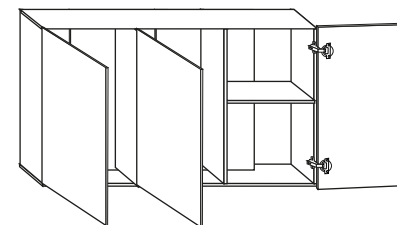

6

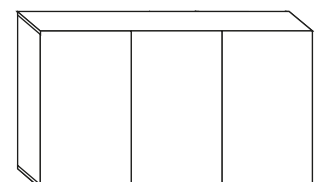



12

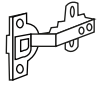

6

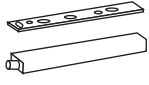

3



28



30



30



8

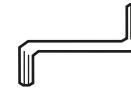

1



Diversa Sp. z o. o.
 u. Krasnowolska 50, 02-849 Warszawa
 Zakład w Prudniku:
 ul. Prężyńska 23, 48-200 Prudnik
 tel. (+48) 77 436 41 11
 e-mail: biuro@diversa.com.pl
 www.diversa.info.pl

Instrukcja montażu — Bauanleitung — Assembly instruction — Instrukce — Instruction de montage — Istruzione di montaggio — Instruccio de montaje

AQUATIC

120x40x90
 120x50x90
 150x50x90

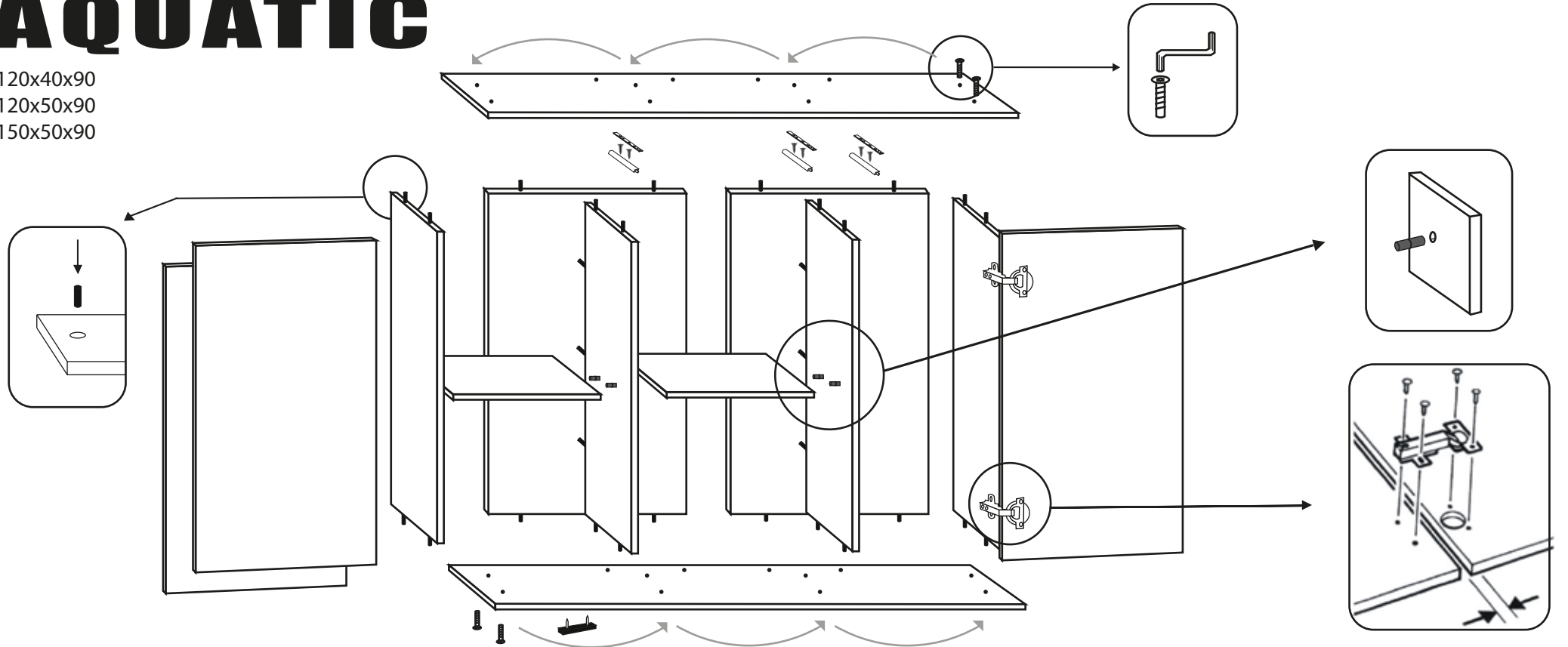

1



2

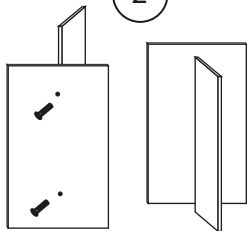

3

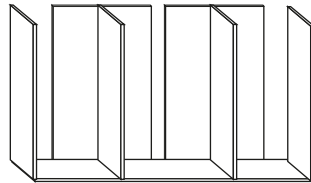

4

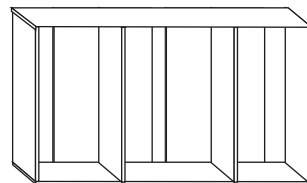

5

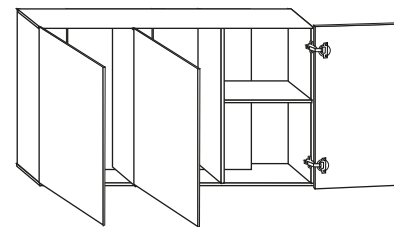

6

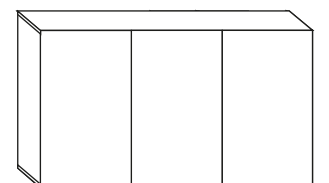



18

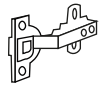

8

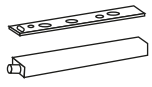

4



48



40



61



8



1



Diversa Sp. z o. o.
 u. Krasnowolska 50, 02-849 Warszawa
 Zakład w Prudniku:
 ul. Prężyńska 23, 48-200 Prudnik
 tel. (+48) 77 436 41 11
 e-mail: biuro@diversa.com.pl
 www.diversa.info.pl

Instrukcja montażu — Bauanleitung — Assembly instrucion — Instrukce — Instruction de montage — Istruzione di montaggio — Instruccio de montaje

AQUATIC

200x60x90
 200x80x90

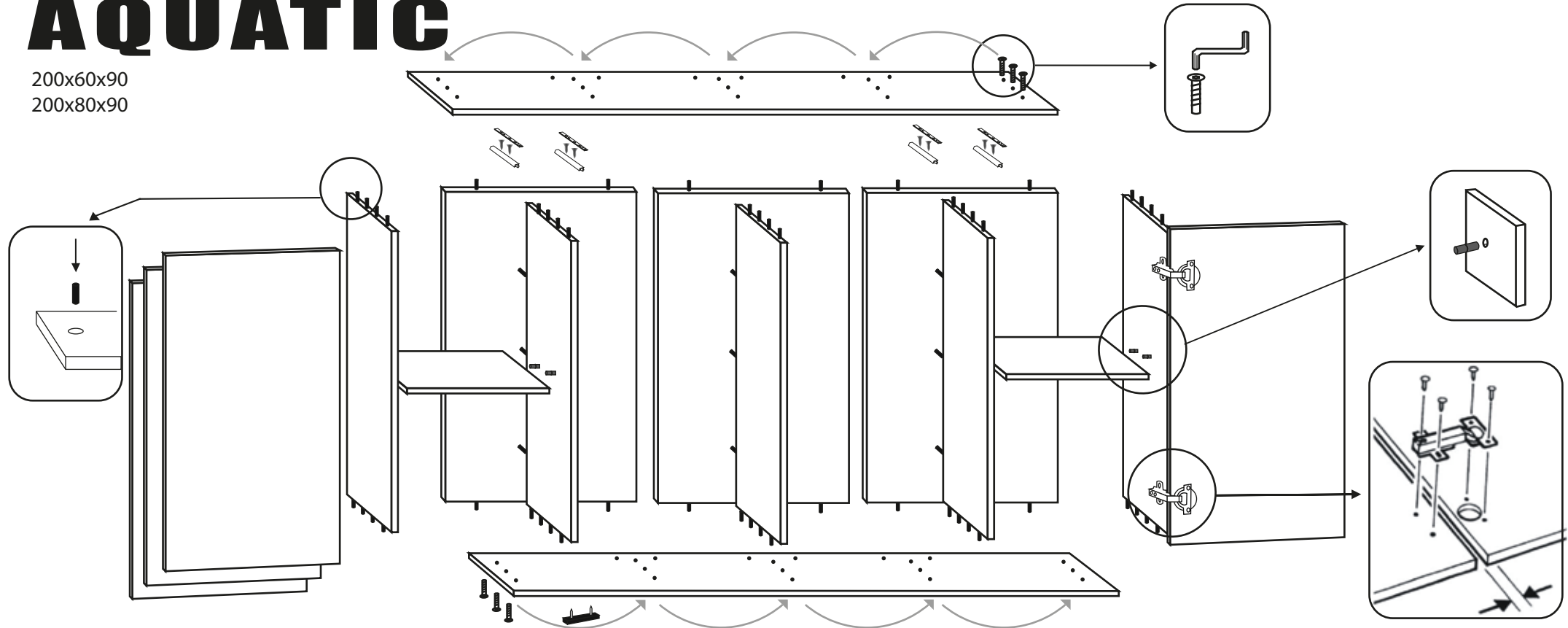

1

2

3

4

5

6

